

Article number: 12715000040120

Description: KLEE-coil 715 000 040.120  
M4 Unhardened, zinc-pl. & chr. yellow

## Measures

---

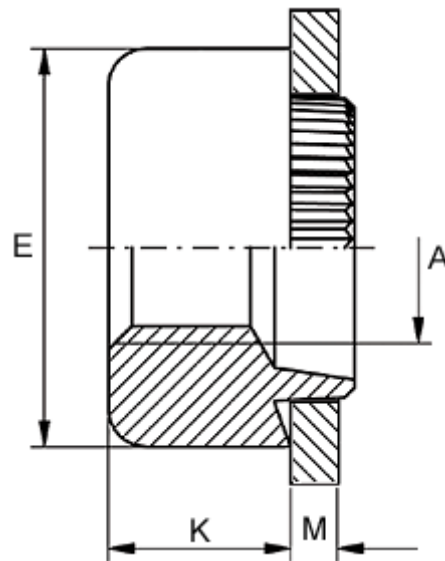

Female thread A	= M4
Height K	= 4.0
Outer diameter E	= 10.0
Plate thickness	= 4.1 to 4.3
Recommended bore diameter for extreme load	= 7.0
Recommended bore diameter for normal use	= 7.0